

ONE TOUCH FITTINGS

Series WP2

Cat No WP2 - 01 - D

ONE TOUCH FITTINGS - M5, 1/8, 1/4, 3/8, 1/2, 3/4, 1"

Features

- Attractive design
- Compact size
- Threaded nipples of L, T & Y fittings enable plastic portion to turn by 360°
- Full area of the inner bore of the tubing is available for flow of fluid
- Bubble tight sealing of tubes
- Suitable for both Nylon and PU tubing
- Easy and quick push-in connection of tube / easy removal of tube by simple pressing of collet cap
- "New design" - Stainless steel collet
- Teflon pre-coated male taper threads
- Maintenance free and long life
- The fitment and function of tubes are not affected by vibrations due to positive gripping of the tube by the collet

Applications

One-touch fittings can be effectively used in all compressed air applications

Some of the pneumatic applications include

- Pneumatic cylinders (all types)
- Directional control valves, solenoid valves and other valves
- Air preparation units, like filter, regulator and lubricators
- Pneumatic control panels
- All compressed air lines, machinery of all kinds wherever pneumatic systems are used
- Pneumatic circuits in any industry

Technical Specifications

Fluid	Air #			
Max. Operating pressure	10 bar			
Ambient temperature	5° - 60° C			
Threaded connection	Male : R - Taper thread Female : G - Parallel thread			
Applicable tube material	Nylon, Polyurethane			
Applicable tube size (OD)	Ø4, 6, 8, 10 and 12 mm			
Recommended tolerance for tube OD	± 0.1 mm			
Recommended minimum wall thickness of tubes	Nylon		PU	
	Tube OD (mm)	Thickness (mm)	Tube OD (mm)	Thickness (mm)
	Ø4 - Ø12	1	Ø4	1
			Ø6	1
			Ø8	1.5
			Ø10	1.5
Ø12			2	

- for other fluids, contact **JANATICS**

ONE TOUCH FITTINGS

Series WP2

Cat No WP2 - 01 - D

Straight Union

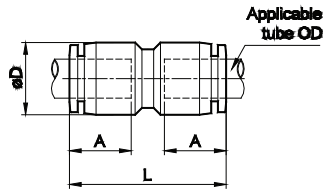

Applicable Tube OD	ØD	L	A	Ordering No
4	10.5	31.5	14.5	WP2100404
6	12.5	33	15.5	WP2100606
8	15	35	16	WP2100808
10	18.5	39.5	18	WP2101010
12	21	41.5	18.5	WP2101212
14	23	42.5	20.5	WP2101414
16	25.5	45.5	22	WP2101616

Different Dia. Straight Union

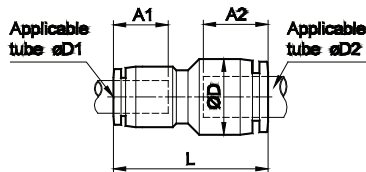

Applicable Tube OD		ØD	L	A1	A2	Ordering No
ØD1	ØD2					
4	6	12.5	32	14.5	15.5	WP2140406
6	8	15	34	15.5	16	WP2140608
6	10	18.5	41	15.5	18	WP2140610
8	10	18.5	37.5	16	18	WP2140810
8	12	21	41	16	18.5	WP2140812
10	12	21	40.5	18	18.5	WP2141012
12	16	25.5	48.5	21.5	22	WP2141216

Union Elbow

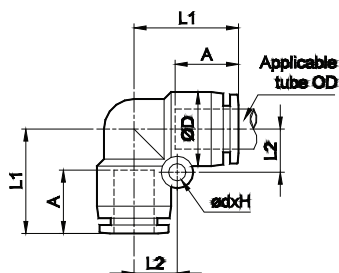

Applicable Tube OD	ØD	L1	L2	A	Ød x H	Ordering No
4	10.5	18.5	6.5	14.5	3.3 x 11	WP2200404
6	12.5	20	7.5	15.5	3.3 x 13	WP2200606
8	15	22	9	16	3.3 x 15.5	WP2200808
10	18.5	26	11	18	4.3 x 19	WP2201010
12	21	27.5	12	18.5	4.3 x 21.5	WP2201212
14	23	29	13	21.5	4.3 x 23.5	WP2201414
16	25.5	31.5	14.5	22.5	4.3 x 26	WP2201616

Union Elbow Reducer

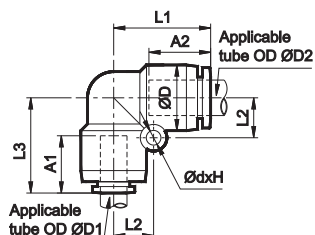

Applicable Tube OD		ØD	L1	L2	L3	A1	A2	Ød x H	Ordering No
ØD1	ØD2								
8	12	21	27.5	12	27	16	18.5	Ø4.3x21.5	WP2200812

A, A1, A2 - Tube insertion length

ONE TOUCH FITTINGS

Series WP2

Cat No WP2 - 01 - D

Union Tee

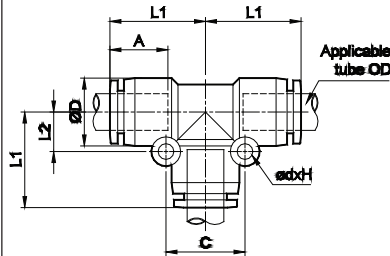

Applicable Tube OD	ØD	L1	L2	C	A	Ød x H	Ordering No
4	10.5	18.5	6.5	13	14.5	3.3 x11	WP2300404
6	12.5	20	7.5	15	15.5	3.3 x13	WP2300606
8	15	22	9	18	16	3.3 x15.5	WP2300808
10	18.5	26	11	22	18	4.3 x19	WP2301010
12	21	27.5	12	24	18.5	4.3 x21.5	WP2301212
14	23	29	13	26	21.5	4.3 x 23.5	WP2301414
16	25.5	31.5	14.5	29	22.5	4.3 x 26	WP2301616

Union Tee Reducer

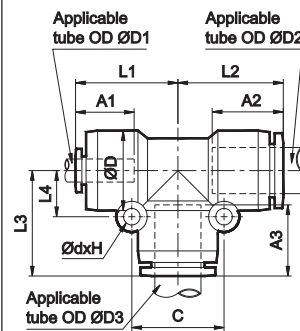

Applicable Tube OD	Applicable Tube OD			ØD	L1	L2	L3	L4	C	A1	A2	A3	Ød x H	Ordering No
	ØD1	ØD2	ØD3											
4	4	6		12.5	23.5	23.5	20	7.5	15	14.5	14.5	15.5	Ø3.3x13	WP230040406
6	6	4		12.5	20	20	23.5	7.5	15	15.5	15.5	14.5	Ø3.3x13	WP230060604
6	6	8		15	25.5	25.5	22	9	18	15.5	15.5	16	Ø3.3x15.5	WP230060608
6	12	12		21	27	27.5	27.5	12	24	15.5	18.5	18.5	Ø4.3x21.5	WP230061212
8	8	6		15	22	22	25.5	9	18	16	16	15.5	Ø3.3x15.5	WP230080806
8	8	10		18.5	28.5	28.5	26	11	22	16	16	18	Ø4.3x19	WP230080810
8	12	12		21	27	27.5	27.5	12	24	16	18.5	18.5	Ø4.3x21.5	WP230081212
10	10	6		18.5	26	26	25	11	22	18	18	15.5	Ø4.3x19	WP230101006
10	10	8		18.5	26	26	28.5	11	22	18	18	16	Ø4.3x19	WP230101008
10	10	12		21	32	32	27.5	12	24	18	18	18.5	Ø4.3x21.5	WP230101012
12	12	6		21	27.5	27.5	27	12	24	18.5	18.5	15.5	Ø4.3x21.5	WP230121206
12	12	8		21	27.5	27.5	27	12	24	18.5	18.5	16	Ø4.3x21.5	WP230121208
12	12	10		21	27.5	27.5	32	12	24	18.5	18.5	18	Ø4.3x21.5	WP230121210

Union 'Y'

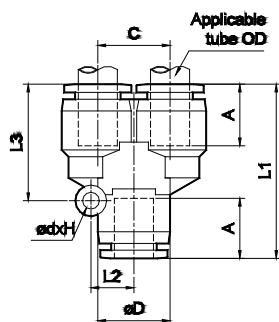

Applicable Tube OD	ØD	L1	L2	L3	C	A	Ød x H	Ordering No
4	10.5	31.5	6.5	19	10	14.5	3.3 x11	WP2400404
6	12.5	34.5	7.5	22	12	15.5	3.3 x13	WP2400606
8	15	38	9	24.5	14.5	16	3.3 x15.5	WP2400808
10	18.5	44	11	29.5	18	18	4.3 x19	WP2401010
12	21	47	12	32	20	18.5	4.3 x21.5	WP2401212

Union 'Y' Reducer

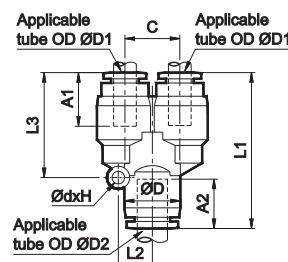

Applicable Tube OD	Applicable Tube OD		ØD	L1	L2	L3	C	A1	A2	Ød x H	Ordering No
	ØD1	ØD2									
4	4	6	12.5	38	7.5	25	12	14.5	15.5	Ø3.3x13	WP240040406
6	6	8	15	41.5	9	28	14.5	15.5	16	Ø3.3x15.5	WP240060608
8	8	10	18.5	46.5	11	32	18	16	18	Ø4.3x19	WP240080810

* M5 threads are supplied with sealing washer
A1, A2, A3 - Tube insertion length

ONE TOUCH FITTINGS

Series WP2

Cat No WP2 - 01 - D

Bulk Head Union

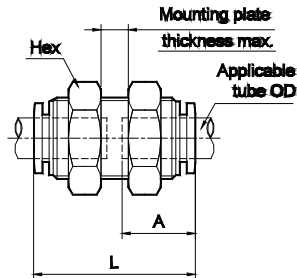

Applicable Tube OD	Hex	L	A	Mounting plate thickness max.	Mounting hole dia	Ordering No
4	14	31.5	14.5	16	12.5	WP2500404
6	17	32.5	15.5	14	14.5	WP2500606
8	19	34	16	12	16.5	WP2500808
10	24	38	18	12	20.5	WP2501010
12	27	39	18.5	12	22.5	WP2501212
14	30	40	19	10	25	WP2501414
16	32	49	23.5	12	28	WP2501616

Bulk Head Female Connector

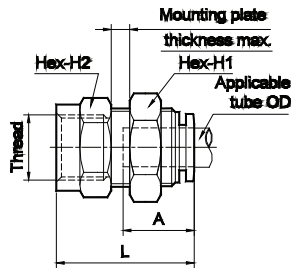

Applicable Tube OD	Thread (G)	Hex H1	Hex H2	L	A	Mounting plate thickness max.	Mounting hole dia	Ordering No
6	1/4	17	17	32	15.5	8	14.5	WP2520661
8	1/4	19	17	32	16	7	16.5	WP2520861

Male Connector

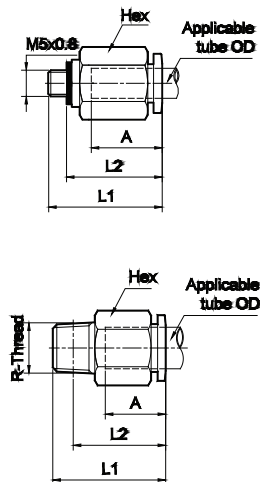

Applicable Tube OD	Thread	Hex	L1	L2	A	Ordering No
4	* M5 x 0.8	10	21	17.5	14.5	WP2110470
	R1/8	10	21.5	18	14.5	WP2110450
	R1/4	14	18	12.5	14.5	WP2110451
6	* M5 x 0.8	12	22	18.5	15.5	WP2110670
	R1/8	12	23	19.5	15.5	WP2110650
	R1/4	14	25.5	20	15.5	WP2110651
	R3/8	17	20	14	15.5	WP2110652
8	R1/8	14	25.5	22	16	WP2110850
	R1/4	14	27	21.5	16	WP2110851
	R3/8	17	22.5	16.5	16	WP2110852
	R1/2	22	25.5	18	16	WP2110853
10	R1/4	17	29.5	24	18	WP2111051
	R3/8	17	30	24	18	WP2111052
	R1/2	22	26	18.5	18	WP2111053
12	R1/4	22	36	30	22.5	WP2111251
	R3/8	22	34.5	29	22.5	WP2111252
	R1/2	22	32.5	25	18.5	WP2111253
14	1/2	24	34	26.5	19	WP2111453
	3/4	27	30	21	19	WP2111454
16	1/2	24	35	27.5	21.5	WP2111653
	3/4	27	32	23	21.5	WP2111654
	1	36	37	27	21.5	WP2111655

* M5 threads are supplied with sealing washer
A - Tube insertion length

ONE TOUCH FITTINGS

Series WP2

Cat No WP2 - 01 - D

Female Connector

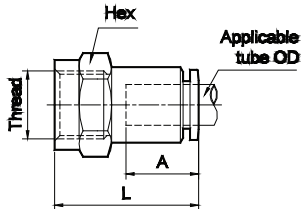

Applicable Tube OD	Thread (G)	Hex	L	A	Ordering No
4	1/8	14	27	14.5	WP2120460
	1/4	17	31	14.5	WP2120461
6	1/8	14	27	15.5	WP2120660
	1/4	17	31.5	15.5	WP2120661
8	1/8	14	27	16	WP2120860
	1/4	17	31.5	16	WP2120861
	3/8	22	33.5	16	WP2120862
10	1/4	17	33	18	WP2121061
	3/8	22	35	18	WP2121062
12	3/8	22	35	18.5	WP2121262
	1/2	27	39.5	18.5	WP2121263
14	1/2	27	39	19	WP2121463

Male Elbow

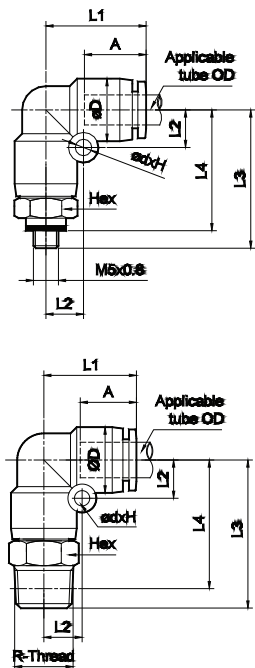

Applicable Tube OD	Thread	Hex	ØD	L1	L2	L3	L4	A	ØdxH	Ordering No
4	* M5 x 0.8	9	10.5	18.5	6.5	25.5	22	14.5	3.3x11	WP2210470
	R1/8	10	10.5	18.5	6.5	30	26.5	14.5	3.3x11	WP2210450
	R1/4	14	10.5	18.5	6.5	32	26.5	14.5	3.3x11	WP2210451
6	* M5 x 0.8	11	12.5	20	7.5	28	24.5	15.5	3.3x13	WP2210670
	R1/8	12	12.5	20	7.5	31.5	28	15.5	3.3x13	WP2210650
	R1/4	14	12.5	20	7.5	33.5	28	15.5	3.3x13	WP2210651
8	R3/8	17	12.5	20	7.5	35	29	15.5	3.3x13	WP2210652
	R1/8	14	15	22	9	33.5	30	16	3.3x15.5	WP2210850
	R1/4	14	15	22	9	37	31.5	16	3.3x15.5	WP2210851
10	R3/8	17	15	22	9	36.5	30.5	16	3.3x15.5	WP2210852
	R1/2	22	15	22	9	42	34.5	16	3.3x15.5	WP2210853
	R1/4	17	18.5	26	11	41.5	36	18	4.3x19	WP2211051
12	R3/8	17	18.5	26	11	42	36	18	4.3x19	WP2211052
	R1/2	22	18.5	26	11	45.5	38	18	4.3x19	WP2211053
	R1/4	19	21	27.5	12	44	38.5	18.5	4.3x21.5	WP2211251
14	R3/8	19	21	27.5	12	44.5	38.5	18.5	4.3x21.5	WP2211252
	R1/2	22	21	27.5	12	47	39.5	18.5	4.3x21.5	WP2211253
	1/2	22	23	29	13	50.5	43	21.5	4.3x23.5	WP2211453
16	3/4	27	23	29	13	51.5	42.5	21.5	4.3x23.5	WP2211454
	1/2	24	25.5	31.5	14.5	54	46.5	22.5	4.3x26	WP2211653
	3/4	27	25.5	31.5	14.5	54	45	22.5	4.3x26	WP2211654
	1	36	25.5	31.5	14.5	61	51	22.5	4.3x26	WP2211655

Extended Male Elbow

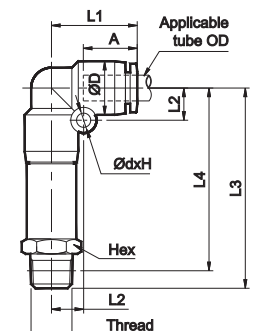

Applicable Tube OD	Thread R	Hex	ØD	L1	L2	L3	L4	A	Ød x H	Ordering No
4	1/4	14	10.5	18.5	6.5	44	37.5	14.5	3.3x11	WP2230451
6	1/8	12	12.5	20	7.5	47	43.5	15.5	3.3x13	WP2230650
	1/4	14	12.5	20	7.5	47.5	42	15.5	3.3x13	WP2230651
8	1/4	14	15	22	9	55	49.5	16	3.3x15.5	WP2230851
10	1/4	17	18.5	26	11	64	58.5	18.5	4.3x19	WP2231051
	3/8	17	18.5	26	11	64.5	58.5	18.5	4.3x19	WP2231052
12	1/2	22	21	27.5	12	71	63.5	18.5	4.3x21.5	WP2231253

* M5 threads are supplied with sealing washer
A - Tube insertion length

ONE TOUCH FITTINGS

Series WP2

Cat No WP2 - 01 - D

Female Elbow

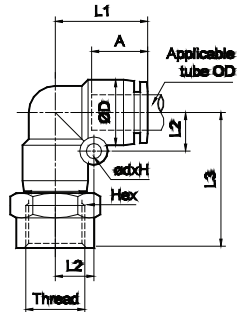

Applicable Tube OD	Thread (G)	Hex	ØD	L1	L2	L3	A	Ød x H	Ordering No
6	1/8	14	12.5	20	7.5	28	15.5	3.3x13	WP2220660
	1/4	17	12.5	20	7.5	33	15.5	3.3x13	WP2220661
8	1/4	17	15	22	9	34	16	3.3x15.5	WP2220861
14	1/2	27	23	29	13	45.5	21.5	4.3x23.5	WP2221463

Male Branch Tee

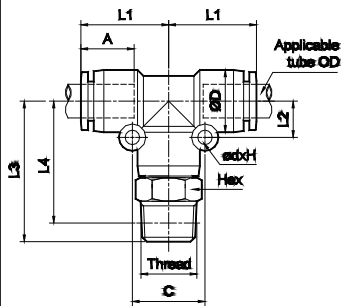

Applicable Tube OD	Thread (R)	Hex	ØD	L1	L2	L3	L4	C	A	ØdxH	Ordering No
4	1/8	10	10.5	18.5	6.5	30	26.5	13	14.5	3.3x11	WP2310450
	1/4	14	10.5	18.5	6.5	32	26.5	13	14.5	3.3x11	WP2310451
6	1/8	12	12.5	20	7.5	31.5	28	15	15.5	3.3x13	WP2310650
	1/4	14	12.5	20	7.5	33.5	28	15	15.5	3.3x13	WP2310651
8	1/8	14	15	22	9	33.5	30	18	16	3.3x15.5	WP2310850
	1/4	14	15	22	9	37	31.5	18	16	3.3x15.5	WP2310851
	3/8	17	15	22	9	36.5	30.5	18	16	3.3x15.5	WP2310852
10	1/4	17	18.5	26	11	41.5	36	22	18	4.3x19	WP2311051
	3/8	17	18.5	26	11	42	36	22	18	4.3x19	WP2311052
12	3/8	19	21	27.5	12	44.5	38.5	24	18.5	4.3x21.5	WP2311252
	1/2	22	21	27.5	12	47	39.5	24	18.5	4.3x21.5	WP2311253
14	1/2	22	23	29	13	50.5	43	26	21.5	4.3x23.5	WP2311453

Female Branch Tee

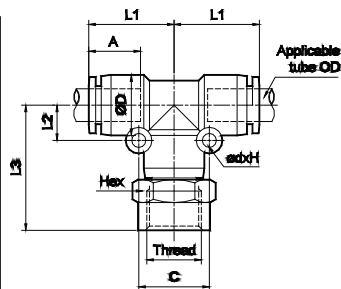

Applicable Tube OD	Thread (G)	Hex	ØD	L1	L2	L3	C	A	Ød x H	Ordering No
6	1/8	14	12.5	20	7.5	28	15	15.5	3.3x13	WP2320660
	1/4	17	12.5	20	7.5	33	15	15.5	3.3x13	WP2320661
8	1/4	17	15	22	9	34	18	16	3.3x15.5	WP2320861

Male Run Tee

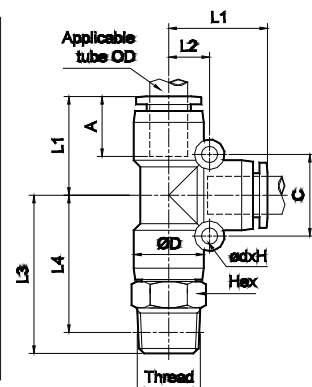

Applicable Tube OD	Thread (R)	Hex	ØD	L1	L2	L3	L4	C	A	Ød x H	Ordering No
4	1/8	10	10.5	18.5	6.5	30	26.5	13	14.5	3.3x11	WP2330450
	1/4	14	10.5	18.5	6.5	32	26.5	13	14.5	3.3x11	WP2330451
6	1/8	12	12.5	20	7.5	31.5	28	15	15.5	3.3x13	WP2330650
	1/4	14	12.5	20	7.5	33.5	28	15	15.5	3.3x13	WP2330651
8	1/8	14	15	22	9	33.5	30	18	16	3.3x15.5	WP2330850
	1/4	14	15	22	9	37	31.5	18	16	3.3x15.5	WP2330851
	3/8	17	15	22	9	36.5	30.5	18	16	3.3x15.5	WP2330852
10	1/4	17	18.5	26	11	41.5	36	22	18	4.3x19	WP2331051
	3/8	17	18.5	26	11	42	36	22	18	4.3x19	WP2331052
12	3/8	19	21	27.5	12	44.5	38.5	24	18.5	4.3x21.5	WP2331252
	1/2	22	21	27.5	12	47	39.5	24	18.5	4.3x21.5	WP2331253

A - Tube insertion length

ONE TOUCH FITTINGS

Series WP2

Cat No WP2 - 01 - D

Female Run Tee

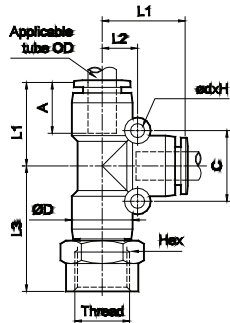

Applicable Tube OD	Thread (G)	Hex	ØD	L1	L2	L3	C	A	Ød x H	Ordering No
6	1/8	14	12.5	20	7.5	28	15	15.5	3.3x13	WP2340660
	1/4	17	12.5	20	7.5	33	15	15.5	3.3x13	WP2340661
8	1/4	17	15	22	9	34	18	16	3.3x15.5	WP2340861

Male Branch 'Y'

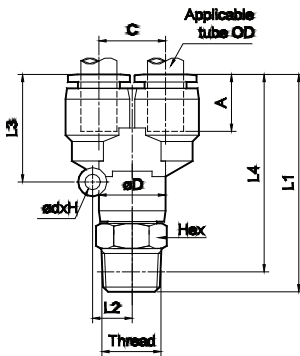

Applicable Tube OD	Thread (R)	Hex	ØD	L1	L2	L3	L4	C	A	ØdxH	Ordering No
4	1/8	10	10.5	42.5	6.5	19	39	10	14.5	3.3x11	WP2410450
	1/4	14	10.5	44.5	6.5	19	39	10	14.5	3.3x11	WP2410451
6	1/8	12	12.5	46	7.5	22	42.5	12	15.5	3.3x13	WP2410650
	1/4	14	12.5	48	7.5	22	42.5	12	15.5	3.3x13	WP2410651
8	1/8	14	15	49.5	9	24.5	46	14.5	16	3.3x15.5	WP2410850
	1/4	14	15	53	9	24.5	47.5	14.5	16	3.3x15.5	WP2410851
	3/8	17	15	52.5	9	24.5	46.5	14.5	16	3.3x15.5	WP2410852
10	1/4	17	18.5	59.5	11	29.5	54	18	18	4.3x19	WP2411051
	3/8	17	18.5	60	11	29.5	54	18	18	4.3x19	WP2411052
12	3/8	19	21	64	12	32	58	20	18.5	4.3x21.5	WP2411252
	1/2	22	21	66.5	12	32	59	20	18.5	4.3x21.5	WP2411253

Male Connector (Internal Hexagon Socket)

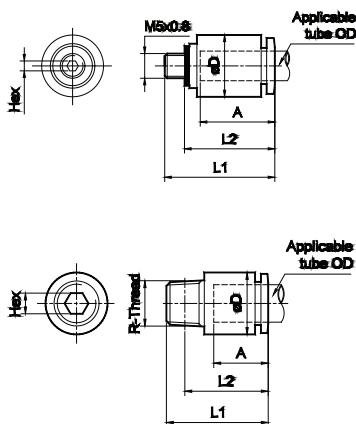

Applicable Tube OD	Thread	Hex	ØD	L1	L2	A	Ordering No
4	* M5 x 0.8	2	10.5	21	17.5	14.5	WP2130470
	R1/8	2.5	10.5	21.5	18	14.5	WP2130450
	R1/4	2.5	13.5	17.5	12	14.5	WP2130451
6	* M5 x 0.8	2	12.5	22	18.5	15.5	WP2130670
	R1/8	4	12.5	23	19.5	15.5	WP2130650
	R1/4	4	13.5	22.5	17	15.5	WP2130651
8	R3/8	4	17	19	13	15.5	WP2130652
	R1/8	4	14.5	25.5	22	16	WP2130850
	R1/4	6	14.5	27	21.5	16	WP2130851
8	R3/8	6	17	22.5	16.5	16	WP2130852
	R1/2	6	21.5	21.5	14	16	WP2130853
	R1/8	4	18	28	24.5	18	WP2131050
10	R1/4	6	18	29.5	24	18	WP2131051
	R3/8	6	18	30	24	18	WP2131052
	R1/2	6	21.5	23.5	16	18	WP2131053
12	R1/4	6	20	32	26.5	18.5	WP2131251
	R3/8	8	20	30.5	24.5	18.5	WP2131252
	R1/2	8	21.5	32.5	25	18.5	WP2131253

* M5 threads are supplied with sealing washer
A - Tube insertion length

ONE TOUCH FITTINGS

Series WP2

Cat No WP2 - 01 - D

Single Swivel (Internal Hexagon Socket)

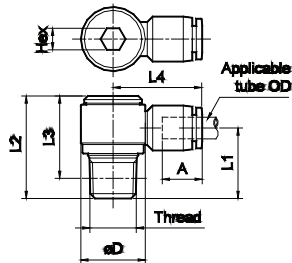

Applicable Tube OD	Thread (R)	Hex	ØD	L1	L2	L3	L4	A	Ordering No
4	1/8	5	13.5	15	22	18.5	22	14.5	WS0210450
6	1/8	5	13.5	15.5	22	18.5	23	15.5	WS0210650
	1/4	6	18	20	28.5	23	25	15.5	WS0210651
8	1/8	5	13.5	17.5	22	18.5	27	17	WS0210850
	1/4	6	18	20.5	28.5	23	27.5	17	WS0210851
	3/8	8	22	23	32.5	26.5	29.5	17	WS0210852
	1/2	10	28	26.5	38	30.5	32.5	17	WS0210853
10	1/4	6	18	22.5	28.5	23	32.5	20	WS0211051
	3/8	8	22	24	32.5	26.5	34.5	20	WS0211052
	1/2	10	28	27.5	38	30.5	36.5	20	WS0211053
12	3/8	8	22	25	32.5	26.5	36	20.5	WS0211252
	1/2	10	28	28.5	38	30.5	37.5	20.5	WS0211253

Single Swivel (Slotted Head)

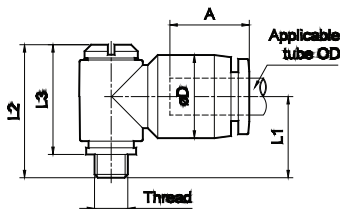

Applicable Tube OD	Thread	ØD	L1	L2	L3	A	Ordering No
4	* M5 x 0.8	10.5	12.5	20	16.5	14.5	WS0010470
6	* M5 x 0.8	12.5	12.5	20	16.5	15.5	WS0010670

Single Swivel (Hexagon Head)

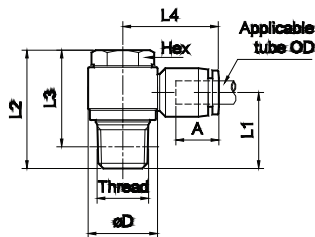

Applicable Tube OD	Thread (R)	Hex	ØD	L1	L2	L3	L4	A	Ordering No
4	1/8	12	13.5	15	24.5	21	22	14.5	WS0110450
6	1/8	12	13.5	15.5	24.5	21	23	15.5	WS0110650
	1/4	14	18	20	30.5	25	25	15.5	WS0110651
8	1/8	12	13.5	17.5	24.5	21	27	17	WS0110850
	1/4	14	18	20.5	30.5	25	27.5	17	WS0110851
	3/8	19	22	23	36.5	30.5	29.5	17	WS0110852
	1/2	24	28	26.5	42	34.5	32.5	17	WS0110853
10	1/4	14	18	22.5	30.5	25	32.5	20	WS0111051
	3/8	19	22	24	36.5	30.5	34.5	20	WS0111052
	1/2	24	28	27.5	42	34.5	36.5	20	WS0111053
12	3/8	19	22	25	36.5	30.5	36	20.5	WS0111252
	1/2	24	28	28.5	42	34.5	37.5	20.5	WS0111253

Double Swivel

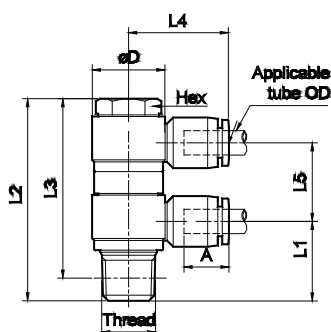

Applicable Tube OD	Thread (R)	Hex	ØD	L1	L2	L3	L4	L5	A	Ordering No
4	1/8	12	13.5	15	40	36.5	22	15.5	14.5	WS0120450
6	1/8	12	13.5	15.5	40	36.5	23	15.5	15.5	WS0120650
	1/4	14	18	20	50	44.5	25	19.4	15.5	WS0120651
8	1/8	12	13.5	17.5	40	36.5	27	15.5	17	WS0120850
	1/4	14	18	20.5	50	44.5	27.5	19.4	17	WS0120851
	3/8	19	22	23	58.5	52.5	29.5	21.6	17	WS0120852
	1/2	24	28	26.5	63.5	56	32.5	21.5	17	WS0120853
10	1/4	14	18	22.5	50	44.5	32.5	19.4	20	WS0121051
	3/8	19	22	24	58.5	52.5	34.5	21.6	20	WS0121052
	1/2	24	28	27.5	63.5	56	36.5	21.5	20	WS0121053
12	3/8	19	22	25	58.5	52.5	36	21.6	20.5	WS0121252
	1/2	24	28	28.5	63.5	56	37.5	21.5	20.5	WS0121253

* M5 threads are supplied with sealing washer
A, A1, A2 - Tube insertion length

ONE TOUCH FITTINGS

Series WP2

Cat No WP2 - 01 - D

Triple Swivel

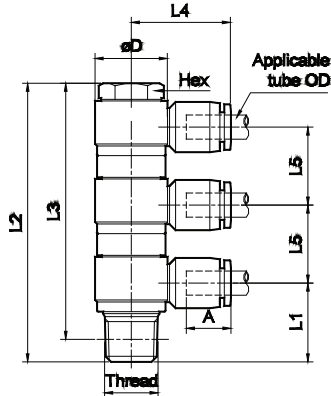

Applicable Tube OD	Thread (R)	Hex	ØD	L1	L2	L3	L4	L5	A	Ordering No
4	1/8	12	13.5	15	55.5	52	22	15.5	14.5	WS0130450
6	1/8	12	13.5	15.5	55.5	52	23	15.5	15.5	WS0130650
	1/4	14	18	20	69.5	64	25	19.4	15.5	WS0130651
8	1/8	12	13.5	17.5	55.5	52	27	15.5	17	WS0130850
	1/4	14	18	20.5	69.5	64	27.5	19.4	17	WS0130851
	3/8	19	22	23	80	74	29.5	21.6	17	WS0130852
10	1/2	24	28	26.5	85	77.5	32.5	21.5	17	WS0130853
	1/4	14	18	22.5	69.5	64	32.5	19.4	20	WS0131051
	3/8	19	22	24	80	74	34.5	21.6	20	WS0131052
12	1/2	24	28	27.5	85	77.5	36.5	21.5	20	WS0131053
	3/8	19	22	25	80	74	36	21.6	20.5	WS0131252
	1/2	24	28	28.5	85	77.5	37.5	21.5	20.5	WS0131253

Multi Distributor Union

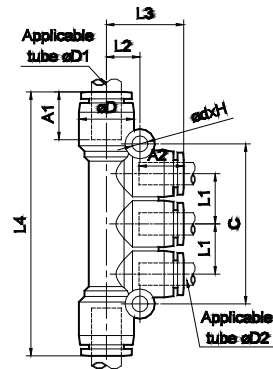

Applicable Tube OD	ØD1	ØD2	ØD	L1	L2	L3	L4	C	A1	A2	ØdxH	Ordering No
6	4	4	12.5	11.5	8	19	60.5	37	15.5	14.5	4.3x13	WD2100604
8	4	4	15	11.5	9	20	63	37	17	14.5	4.3x15.5	WD2100804
8	6	6	15	13.5	9	21	71	43	17	15.5	4.3x15.5	WD2100806
10	6	6	18.5	13.5	11	22	76	43	20	15.5	4.3x19	WD2101006
10	8	8	18.5	16	11	24	82	51	20	17	4.3x19	WD2101008
12	8	8	21	16	12	24	84.5	51	20.5	17	4.3x21.5	WD2101208
12	10	10	21	19.5	12	27.5	92.5	61	20.5	20	4.3x21.5	WD2101210

Multi Distributor Male

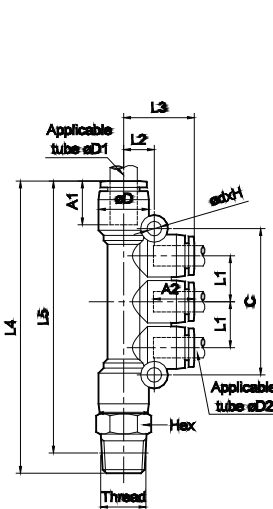

Applicable Tube OD	Thread (R)	Hex	ØD	L1	L2	L3	L4	L5	C	A1	A2	ØdxH	Ordering No
6	1/8	12	12.5	11.5	8	19	72	68.5	37	15.5	14.5	4.3x13	WD211060450
	1/4	14	12.5	11.5	8	19	74	68.5	37	15.5	14.5	4.3x13	WD211060451
	3/8	17	12.5	11.5	8	19	75	69	37	15.5	14.5	4.3x13	WD211060452
8	1/8	14	15	11.5	9	20	74.5	71	37	17	14.5	4.3x15.5	WD211080450
	1/4	14	15	11.5	9	20	78	72.5	37	17	14.5	4.3x15.5	WD211080451
	3/8	17	15	11.5	9	20	77.5	71.5	37	17	14.5	4.3x15.5	WD211080452
8	1/8	14	15	13.5	9	21	82.5	79	43	17	15.5	4.3x15.5	WD211080650
	1/4	14	15	13.5	9	21	86	80.5	43	17	15.5	4.3x15.5	WD211080651
	3/8	17	15	13.5	9	21	85.5	79.5	43	17	15.5	4.3x15.5	WD211080652
10	1/4	17	18.5	13.5	11	22	91.5	86	43	20	15.5	4.3x19	WD211100651
	3/8	17	18.5	13.5	11	22	92	86	43	20	15.5	4.3x19	WD211100652
	1/2	22	18.5	13.5	11	22	95.5	88	43	20	15.5	4.3x19	WD211100653
10	1/4	17	18.5	16	11	24	97.5	92	51	20	17	4.3x19	WD211100851
	3/8	17	18.5	16	11	24	98	92	51	20	17	4.3x19	WD211100852
	1/2	22	18.5	16	11	24	101.5	94	51	20	17	4.3x19	WD211100853
12	3/8	19	21	16	12	24	101	95	51	20.5	17	4.3x21.5	WD211120852
	1/2	22	21	16	12	24	103.5	96	51	20.5	17	4.3x21.5	WD211120853
12	3/8	19	21	19.5	12	27.5	109	103	61	20.5	20	4.3x21.5	WD211121052
	1/2	22	21	19.5	12	27.5	111.5	104	61	20.5	20	4.3x21.5	WD211121053

A, A1, A2 - Tube insertion length

ONE TOUCH FITTINGS

Series WP2

Cat No WP2 - 01 - D

Self Sealing Fittings



These one touch fittings (with built in self seal) seal automatically once the tubing has been removed

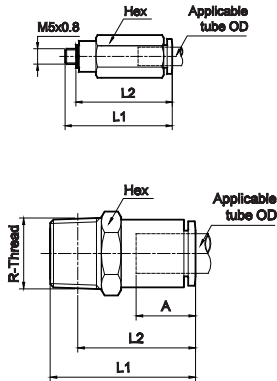

Applicable Tube OD	Thread	Hex	L1	L2	A	Ordering No	Tube Pushing Force in kg #
4	* M5 x 0.8	10	32.5	29	15.5	WE20110470	2.5
	R1/8	10	27	23.5	15.5	WE20110450	
	R1/4	14	27	21.5	15.5	WE20110451	
6	* M5 x 0.8	12	35	31.5	16.5	WE20110670	4
	R1/8	12	29	25.5	16.5	WE20110650	
	R1/4	14	29	23.5	16.5	WE20110651	
8	R1/8	14	35	31.5	18.5	WE20110850	6
	R1/4	14	35.5	30	18.5	WE20110851	
	R3/8	17	36	30	18.5	WE20110852	
10	R1/4	17	38	32.5	20.5	WE20111051	8.5
	R3/8	17	38.5	32.5	20.5	WE20111052	
	R1/2	22	39	31.5	20.5	WE20111053	
12	R3/8	19	44	38	22.5	WE20111252	11
	R1/2	22	44.5	37	22.5	WE20111253	

for air pressure of 7 bar

Cross Union

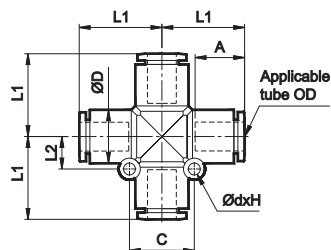

Applicable Tube OD	ØD	L1	L2	C	A	ØdxH	Ordering No
4	10.5	18.5	6.5	13	15.5	3.3 x 11	WP2700404
6	12.5	20	7.5	15	16.5	3.3 x 13	WP2700606
8	15	23	9	18	18	3.3 x 15.5	WP2700808
10	18.5	27	11	22	20	4.3 x 19	WP2701010
12	21	28.5	12	24	21.5	4.3 x 21.5	WP2701212

Plug

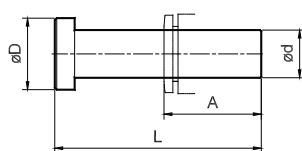

Applicable Fitting size Ød	ØD	L	A	Ordering No
4	10	42	14.5	WP2600400
6	12	44	15.5	WP2600600
8	14	46	17	WP2600800
10	16	48	20	WP2601000
12	18	52	20.5	WP2601200

* M5 threads are supplied with sealing washer
A, A1, A2 - Tube insertion length

ONE TOUCH FITTINGS

Series WP2

Cat No WP2 - 01 - D

Tube



Tube OD in mm		Ø4	Ø6	Ø8	Ø10	Ø12
Ordering no. for	Nylon	WH01W04	WH01W06	WH01W08	WH01W10	WH01W12
	PU	WH00B04	WH00B06	WH00B08	WH00B10	WH00B12

Colour : Nylon - White PU - Blue

Usage instructions

(For maximum efficiency)

- Cut the tube - end burr free and square, using **Tube cutter (WC1)** and clean the edge to ensure leak tight joints. (Do not use blunt tools / hacksaw / chisel etc,,)
- Ensure the tube is fully inserted into the fitting - until the positive stop, beyond the '**U**' seal.
- Tightening torque for threaded components

Thread size	Tightening torque Nm
M5	1 - 1.5
1/8	7 - 9
1/4	12 - 14
3/8	22 - 24
1/2	28 - 30

- Minimum bend radius of the tubing to avoid leakage

Min. bend radius for (in mm)	OD of tube	Ø4	Ø6	Ø8	Ø10	Ø12
	Nylon	15	30	50	65	90
	PU	10	15	25	30	35

Tube Cutter

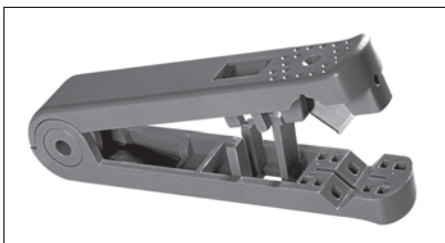

Ordering No	WC1
-------------	-----

Can cut tubes upto Ø12mm OD

How to Order

While ordering fittings, mention the Ordering number given in the corresponding tables, and for tubes, mention the ordering number with required length in metres.